

Verify this report at [GIA.edu](http://GIA.edu)

### GIA NATURAL COLORED DIAMOND REPORT

January 23, 2024

Report Type ..... Grading Report

GIA Report Number .....

Shape and Cutting Style ..... Pear Modified Brilliant

Measurements ..... 9.68 x 5.84 x 3.63 mm

Carat Weight ..... 1.50 carat

Color Grade ..... Fancy Brownish Yellow

Color Origin ..... Natural

Color Distribution ..... Even

Clarity Grade ..... SI1

Proportions:

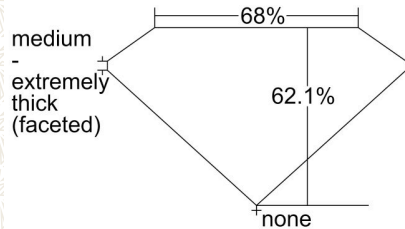

Profile not to actual proportions

Polish ..... Very Good

Symmetry ..... Very Good

Fluorescence ..... Faint

Inscription(s): GIA

Comments: Clouds, pinpoints and surface graining are not shown.

### ADDITIONAL INFORMATION

#### GIA COLORED DIAMOND SCALE

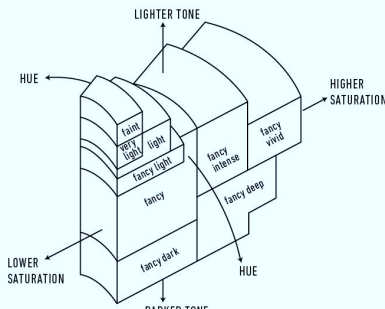
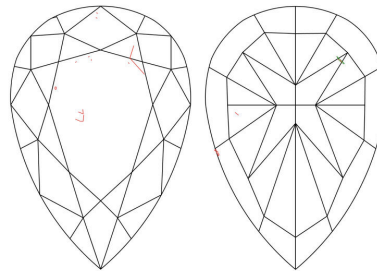

Illustration of GIA fancy color grade interrelationships





#### GIA CLARITY SCALE

FLAWLESS
INTERNALLY FLAWLESS
VVS <sub>1</sub>
VVS <sub>2</sub>
VS <sub>1</sub>
VS <sub>2</sub>
SI <sub>1</sub>
SI <sub>2</sub>
I <sub>1</sub>
I <sub>2</sub>
I <sub>3</sub>

#### CLARITY CHARACTERISTICS



#### KEY TO SYMBOLS\*

-  Feather
-  Crystal
-  Cavity
-  Needle
-  Extra Facet

\* Red symbols denote internal characteristics (inclusions). Green or black symbols denote external characteristics (blemishes). Diagram is an approximate representation of the diamond, and symbols shown indicate type, position, and approximate size of clarity characteristics. All clarity characteristics may not be shown. Details of finish are not shown.



[reportcheck.gia.edu](http://reportcheck.gia.edu)

The results documented in this report refer only to the diamond described, and were obtained using the techniques and equipment available to GIA at the time of examination. This report is not a guarantee or valuation. For additional information and important limitations and disclaimers, please see [GIA.edu/terms](http://GIA.edu/terms) or call +1 800 421 7250 or +1 760 603 4500. ©2023 Gemological Institute of America, Inc.

